

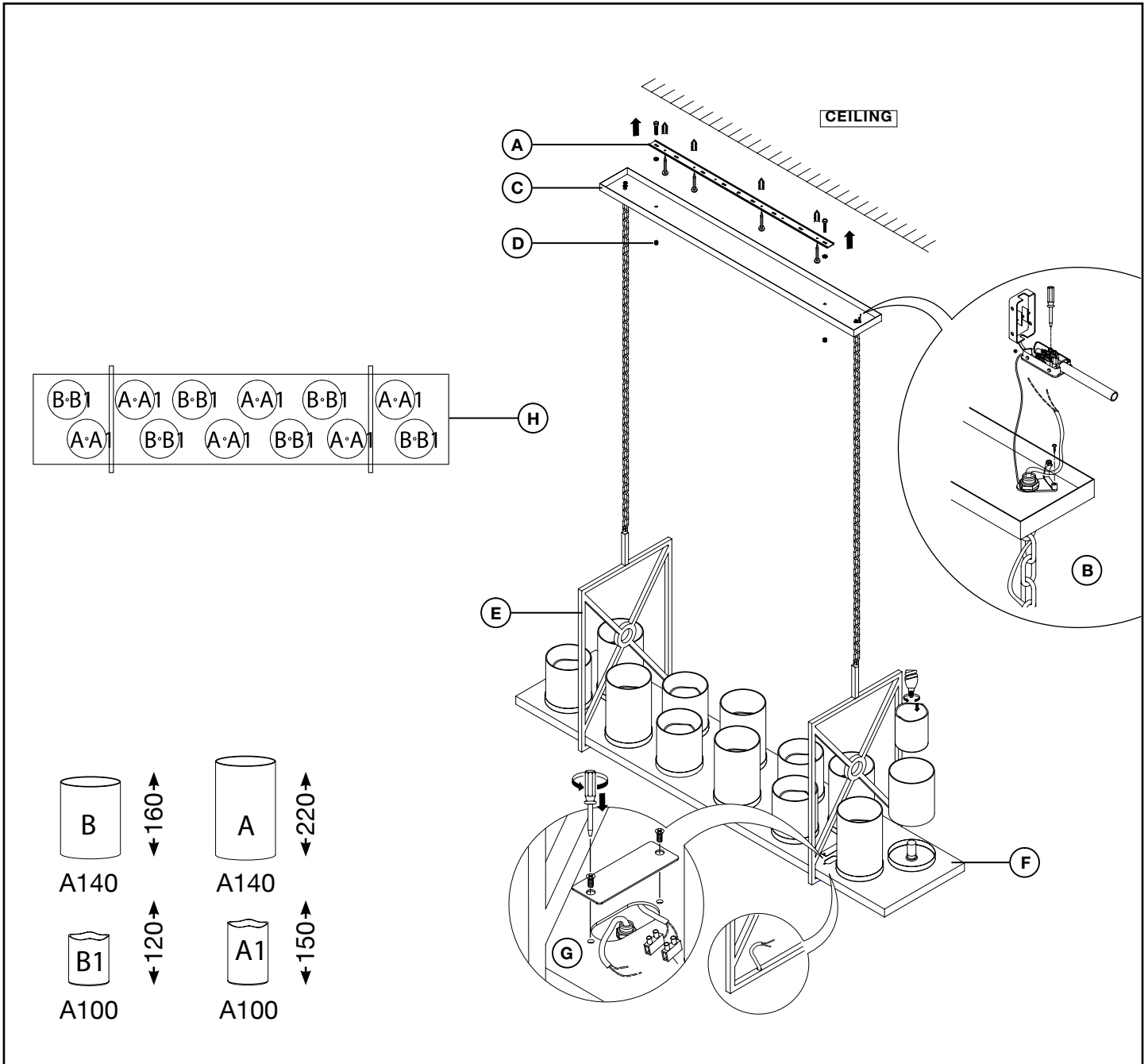

E I C H H O L T Z

110444 CHANDELIER SUMMIT

ASSEMBLY INSTRUCTION



Turn off the electricity supply at the main circuit panel before installing.
Do not connect the electricity supply until your luminaire is fully assembled and installed.

Take the side panels (E) and the luminaire (F) from the carton. Slide the side panels over the luminaire until they fall into place while leading the wire from the side panel through the bottom of the luminaire to the top. Now connect the wires from the side panel and the wire from the luminaire and place the connection inside the luminaire (G). Close the hole with the supplied cap.

Fix the ceiling plate (A) to the ceiling by using mounting plugs and screws suitable to your ceiling type.

Place the luminaire in an elevated position in such a way that the wires can freely reach the ceiling junction box.

Thread the wires through the components and connect the 3 power wires according to their colours (B). Brown is the live wire, blue is the neutral wire, green/yellow is the earth wire.

Place the ceiling canopy (C) over the ceiling bracket and fix it securely with the 3 nuts supplied (D).

Hang the luminaire from the ceiling canopy with chains.

Place the lightbulbs (maximum 5 Watt). Place the "candles" according to the schedule (H).